

## User and Fitting Manual

June 2008

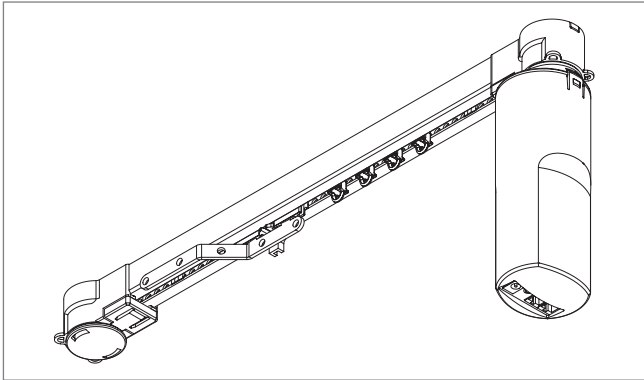

Electric Curtain Track System Silent Gliss 5090



Copyright June 2008 by Silent Gliss International Ltd., 3073 Gumligen/Berne (Switzerland)  
Realised by Silent Gliss International, Group Headquarters

Printed in Switzerland

Version 1

## Table of Contents

Failure to observe the following instructions may invalidate the Silent Gliss warranty.

1	Fitting Information	_____	4
2	Silent Gliss 5090 Basic Operation Method: With Switch	_____	9
3	Option 1: Silent Gliss 5090IR	_____	10
4	Option 2: Silent Gliss 5090TL	_____	14
5	Option 3: Silent Gliss 5090TC	_____	22
6	Problem Solver	_____	23

### **Important:**

Before using your system Silent Gliss 5090, please read these instructions carefully and keep them safe for future reference.

A few minutes spent familiarising yourself with these components will save you time when carrying out the installation.

# 1 Fitting Information

## 1.1 Deciding the best position

### Points to consider when planning your installation

The system Silent Gliss 5090 may trigger some types of burglar alarm. This may usually be remedied by relocation of, or a change of burglar alarm sensor. If in doubt, consult your burglar alarm supplier.

It may be easiest to have the power supply on the same side of the window as the nearest plug socket.

You might choose to position the power supply so that it is not visible and not touchable.

The transformer should not be placed where there is a risk of condensation dripping onto it from a window sill or used in damp environments such as bathrooms.

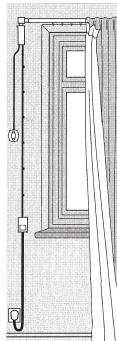

**When fixing avoid any hidden cabling in wall. If in doubt consult a qualified electrician.**

### Tools for fixing

Your system track is ready assembled for easy fixing. Your track pack contains everything you need to fix the track to a wooden batten. If fixing directly to a wall or ceiling, appropriate fixings; e.g. wall plugs will also be needed.



### Bracket position

Draw a level line on the ceiling, wall or batten at the height you wish to position the track.  
Ask your supplier about the appropriate kind of bracket.

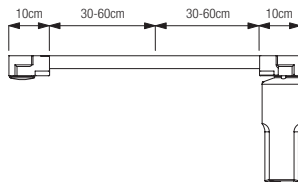

Note: The distance\* depends on the kind of curtain used. Check that nothing disturbs the curtain for example: radiator, window handle etc.

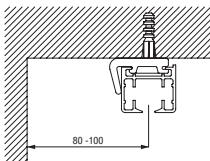

Top fix with bracket 3826

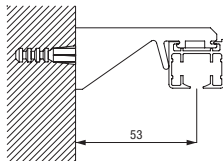

Wall fix with bracket 3836

## 1.2 Fitting the motor

### Fitting the motor unit to the predetermined end of the track

Slide back locking plate (1) and remove. Locate motor drive shaft (2) into pulley drive (3) inside pulley housing (5). Fully insert motor (4) into pulley housing (5) and twist to secure motor unit onto pulley housing as shown. Replace locking plate (1) to lock the motor firmly in position.

**Note: You may need to turn motor slightly to left or right to ensure locking plate locates completely with a click.**

To remove motor, if necessary, reverse instructions above.

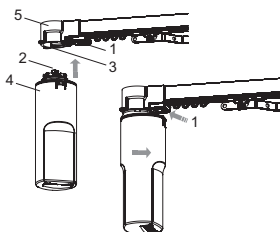

### 1.3 Fixing the hook tape to the transformer and the fixing plate to the wall

Clean rear of transformer case, remove velcro hook strips from fixing plate (1). Stick velcro hook strips in position centrally above and below the certification sticker on the rear of the transformer case (2) lining up with velcro loop section on the fixing plate.

Position wall holder and mark through fixing lugs onto the wall. Drill fixing holes using a 6mm drill, insert wall plugs provided and screw fixing plate (3) to wall.

In the event of the mains cable not reaching a convenient mains socket, we would advise you to have an additional socket fitted by a qualified electrician.

Tidy the run of cable between the transformer and motor unit with the cable clips provided. When fixing avoid any hidden fixing cabling in the wall. If in doubt consult a qualified electrician

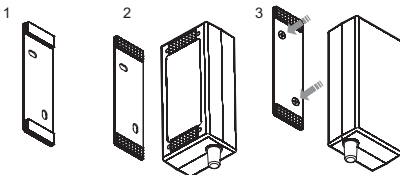

### 1.4 Connecting the motor

Connect transformer to mains power with lead supplied (do not switch on power at this stage). Plug in transformer output into port (1) on the bottom of the motor. Black wheel (2) is channel for IR sensor (optional) see section 3.

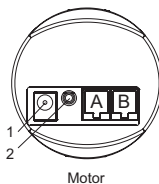

Motor

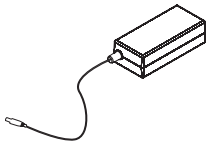

Transformer (with cable)

Plug A is for the cable of the timer or switch  
 Plug B is for the infrared sensor or switch

## 1.5 Fixing the switch

Lever switch cover off switch using a flat bladed screwdriver near the cable. There are two options for fitting the cable of the switch.

- A. **Concealed fitting** the switch is supplied with cable entering from the back to allow concealment of cable.
- B. **Surface fitting** break off the blanking piece (1) from the edge of the switch backplate as shown allowing the cable to fit flush to the wall.

Position the switch and mark through holes onto the wall (2).  
 Drill fixing holes using a 6mm drill, insert wall plugs provided and screw switch to wall (3). Replace cover.  
 Fix cable to wall with cable clips provided.

**Note: All cables are fitted with non-rewireable plugs and cannot be shortened.**

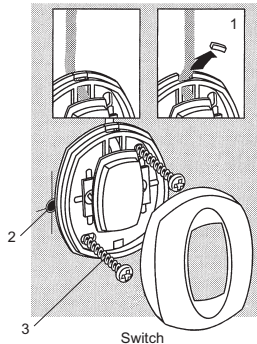

## 1.6 Adding or removing gliders

**Single Stack:** First remove the motor (see "Fitting the Motor" on previous page). Insert gliders through the slot.

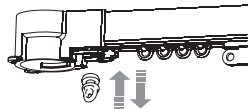

**Pair Stack:** On the opposite side of the motor, remove only the locking plate, there will be enough space to add or remove gliders.

**Note: When hanging your curtains the heading must be under-slung – i.e. the top of the curtains must be completely below the curtain track profile, failure to do so could invalidate the warranty.**

## 1.7 Setting or adjusting the end stops

Having hung your curtains to the track, you can now adjust the end stops if necessary.

If required, you can control how far the curtains draw back by means of the end stop (1).

Carefully loosen end stop (2) locking screw.

Slide the stop along the channel to the point that you want the curtains to dress to when open or close and then fully re-tighten screw.

Re-test to the open position and re-adjust end stop (1).

**Note: In order to avoid damage of the system, the belt carrier (3) must run into the end stop (1) on both sides.**

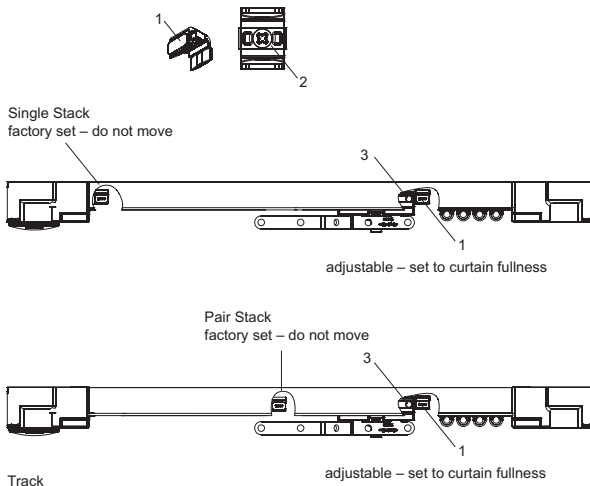



## 2 Silent Gliss 5090 Basic Operation Method: With Switch

### Connecting motor

The switch can now be plugged in to either position A or B.

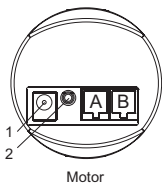

### Operating your curtain track with switch

Press switch » curtain moves  
Press switch during moving » curtain stops  
Press switch again » curtain moves back

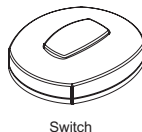

### 3 Option 1: Silent Gliss 5090IR

- 1) Motor
- 2) Switch
- 3) Infrared Sensor
- 4) Transformer
- 5) Main Plug

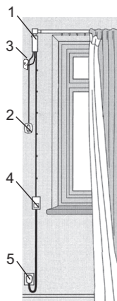

- 1) Remote control
- 2) Wall bracket
- 3) Self-adhesive cover
- 4) Sensor unit
- 5) Mounting clip - sensor
- 6) Cable - sensor
- 7) Plug B - sensor
- 8) Cable clips

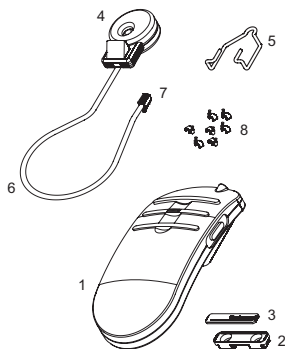

Infrared Set IR SG 5093

### 3.1 Remote control

The system can be conveniently operated from anywhere in the room using the remote control (Ideal for curtains that may be difficult to reach). Visible contact between sensor and remote control is necessary in order to dependably operate the system.

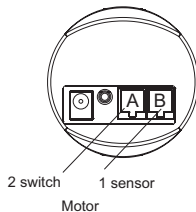

### 3.2 Connecting motor and infrared sensor

Unplug motor from mains.

Plug the infrared sensor into the position B on the motor.

Additionally, the switch could also be plugged into position A on the motor. (see Basic 5090 operation section 2)

Decide where you wish to locate the sensor (4). It can be fixed to the wall by mounting clip (5) and screw (9) or clipped to a curtain by the mounting clip (5). The sensor should be in full view, not hidden behind the curtain or track.

Attach the sensor (4) to the wall or curtain and secure cable with clips (8) provided.

Note: The mounting clip (5) can be removed from the sensor (4) for fixing or adjusting the angle of the sensor.

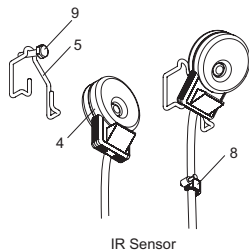

### 3.3 Wall mounting the remote control

You may wish to mount the remote handset (1) to a convenient wall near the door or close to a light switch. A wall mounting bracket (2) is provided for this purpose.

**Important:** Do not attempt to fix mounting bracket where there is a possibility of hidden cables, e.g. directly above or below a light switch. If in doubt, consult a qualified electrician.

To fit mounting bracket position, level and mark holes of mounting bracket (2). Drill two holes and insert wall plugs.

Secure mounting bracket (2) to wall with screws provided.

Attached self-adhesive cover (3) onto mounting bracket (2) to cover screw heads.

The handset locate rest securely on this bracket but remains easily detachable for use anywhere in your room.

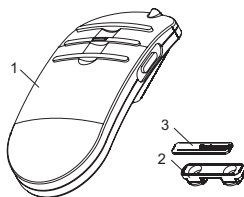

IR Remote Control

### 3.4 Controlling more than one track

You can use the handset to operate one or more systems by using the channel selector switch. There are four positions, 1,2,3 and 123(All).

The motor is preset to receive all channels.

If you have more than one system in the same room and you would like to operate them independently, you will need to set each motor to a separate channel as follows:

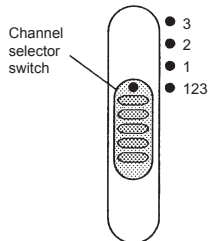

Side view of the remote control

#### Adjusting and testing the infrared system

If you have just one track and no other infrared systems in your house, then the easiest way is to set the remote control to position 123(All).

If you have more than one system and would like to control them separately, choose remote control position 1 and turn the black wheel (1) with small flat blade screwdriver to position 1 on the first motor.

For the second motor, set the switch on the remote control to position 2 and turn the black wheel on the second motor to position 2.

For the third motor, set the switch on the remote-control to position 3 and turn the black wheel (potentiometer) on the third motor to position 3.

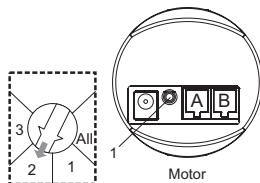

## 4 Option 2: Silent Gliss 5090TL

### 4.1 Fixing the timer unit

The timer unit is fixed to the wall by means of the fixing bracket (1). When fixing, avoid any hidden cabling in the wall. If in doubt, consult a qualified electrician.

Drill 6mm holes, insert wall plugs provided and screw wall bracket to wall.



Before mounting the timer unit onto the bracket, plug the motor cable into position A and the light sensor into position C (see next page). You have the possibility to hide the cable on the rear side of the timer unit. Both cables could leave timer unit on the left or right side or one cable to the left and the other to the right, depending on where motor and light sensor are located.

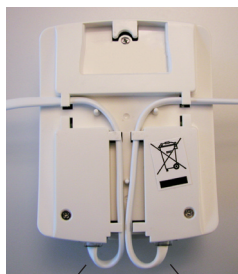

Rear of Timer

C

A

## 4.2 Connecting motor & timer

- 1) Unplug motor from mains.
- 2) Plug the timer unit cable into position A on the motor (1).
- 3) Plug in the other side of the cable into position A on the timer unit (2).
- 4) Plug in the light sensor into position C on the timer unit (3).
- 5) Additionally, the switch could be plugged into position B on the motor.

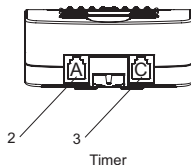
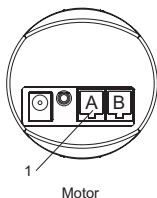

### 4.3 Fixing the light sensor

The light sensor should be positioned behind the curtains facing the window to detect changing levels of light.

Different locations can affect the opening times of curtains as follows.

- Sensor faced towards rising sun – will open and close earlier.
- Sensor faced towards setting sun – will open and close later.
- Angling the sensor away from the window into the room – will open later and close earlier.

Fix the light sensor to the window frame or inside the window reveal with the adhesive pad. Tidy the cable with cable clips to the timer unit.

### 4.4 Activating the timer unit

To activate the timer unit turn on mains power. The display panel should now indicate a time of 12:00 hours.

Now try the operation using the open-stop-closed buttons.

- 1) Option button
- 2) Reset button
- 3) Display
- 4) Clock controls
- 5) Close
- 6) Stop
- 7) Open

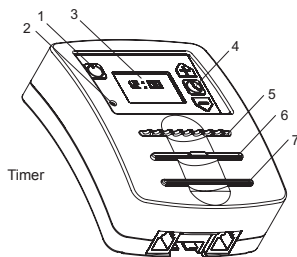







## Programming the timer unit

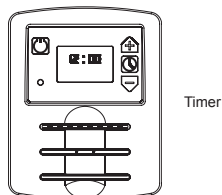



When you plug in the timer Unit, it is factory set;

Clock 12:00  
 Timer Open 09:00  
 Timer Close 19:00







To set timer to the correct time:  
 Press , a flashing clock will appear.  
 Set time using  or .



To set timer opening:  
 Press , a flashing open symbol  and opening time will appear. You can now reset the opening time using the  or  controls.  
 Press  when finished.



To set timer closing:  
 Press , a flashing closed symbol  and closing time, now show. You can now set the closing time, again using the  or  controls.  
 Press  when finished.



This completes the setting procedure.  
 Press  until both symbols appear.  
 Your timer is now set to operate for both open and closed operations.

## Continued

Select your desired control method

Press  and the system will scroll through the following options with each press of the button.



Start point; timer operates for both open and close.



Open on timer and close on light sensor (when fitted).



Close on timer and open on light sensor (when fitted).



Timer and light sensor not operational, switch control through switch on timer only.



Light sensor operates both open and close (timer not activated).



## 4.5 Light sensor adjustments

Your unit is pre-set to switch at an average light intensity for both open and close. However, you may wish to adjust the light sensor level required to trigger the curtain operation.

Using the option button  select clock only.

### First mode (Dawn and Dusk)



Now press and hold the following 2 buttons   and then  all simultaneously.



The number 50 shows up. The sensitivity is divided between 1 and 100 for dark and bright.

1 = The curtains will **open** with minimum of light.

100 = The operation requires brighter light to **open** the curtains.

The first mode setting is common for both the open and close functions. To return to normal operation press  button.

### Functional test of light sensor

When in this part of the set-up procedure, the light sensor can be functionally tested and will respond immediately.



Cover the light sensor and the curtains will close, uncover the sensor and the curtains will open.

**You can use the open-stop-close buttons at any time without affecting the automatic settings. The timer gets back to light mode after a 24 hour cycle.**

## Second mode (Sun protection)

In Sun protection mode the curtain will close in high levels of direct sunlight to control temperatures or protect room interiors.



Now press and hold the following 2 buttons   and then  all simultaneously.



The number 50 shows up. By pressing the button  long enough you get after 0 to -100. There you have to possibility to choose between -100 and -900.  
-100 = The curtains close with less light.  
-900 = The curtains close with direct sunshine into the sensor (bright sunlight)

The first mode setting is common for both the open and close functions. To return to normal operation press  button.

The second mode works only on this display position.



**Note: Opening and closing times will vary with changing weather conditions.**

**You can use the open-stop-close buttons at any time without affecting the automatic settings. The timer gets back to light mode after a 24 hour cycle.**

### Reversing open-close direction

**Note:** Depending on which way round you have chosen for your curtains to operate, you may find the open and close controls on the main control are reversed.

To reverse the direction, proceed as follows:

- 1) Set the curtains to half open / half closed (this is so that the system can run in either direction when the procedure is completed)
- 2) Disconnect the power plug from the motor unit.
- 3) Wait for 30 seconds to allow the capacitors in the motor unit to discharge
- 4) Press and hold a manual operating switch (note: this must be one of the simple switches, NOT the buttons on the timer unit)
- 5) Whilst still holding the switch, reconnect the power plug.
- 6) The motor will now run in the new 'open' direction.
- 7) The switch can be released once the motor has started to run.

The switch used for this setting can be connected into either position A or B on the motor.

## 5 Option 3: Silent Gliss 5090TC

The Silent Gliss 5090TC combines all control options from Silent Gliss 5090IR and 5090TL, for connection instructions please refer to sections 3 and 4.

**Please note the manual switch cannot be used if the light sensor is connected (switch included in kit).**

## 6 Problem Solver

Problem	Possible cause	What to do
Switch does not operate curtain	<ul style="list-style-type: none"> <li>a) Not plugged in at mains or fuse blown</li> <li>b) Loose plugs at motor unit</li> <li>c) Motor unit fault</li> </ul>	<ul style="list-style-type: none"> <li>a) Check mains plug or change fuse if necessary</li> <li>b) Connect plugs into motor unit</li> <li>c) Refer to supplier</li> </ul>
Infra-red does not operate curtain	<ul style="list-style-type: none"> <li>a) Battery in remote flat</li> <li>b) Infra-red sensor is not connected</li> <li>c) Infrared sensor is covered</li> <li>d) Not the same frequency on the remote and the motor</li> </ul>	<ul style="list-style-type: none"> <li>a) Change batteries on remote</li> <li>b) Plug Infrared sensor into B on the motor unit</li> <li>c) Reposition Infrared sensor</li> <li>d) Change the frequency on the remote to 123 (All) and try</li> </ul>
Timer unit not functioning	<ul style="list-style-type: none"> <li>a) Timer unit not activated</li> <li>b) Not plugged in</li> </ul>	<ul style="list-style-type: none"> <li>a) Press reset button</li> <li>b) Plug in on position A timer unit and A motor unit</li> </ul>
Light sensor does not operate curtains	<ul style="list-style-type: none"> <li>a) Light sensor or timer unit not connected</li> <li>b) Sensitivity incorrectly adjusted</li> </ul>	<ul style="list-style-type: none"> <li>a) Plug Light sensor into C on timer unit, plug timer unit A to motor unit A</li> <li>b) Adjust setting</li> </ul>
Light closes or open not correctly	<ul style="list-style-type: none"> <li>a) Sensitivity incorrectly adjusted</li> <li>b) Not correct daylight.</li> </ul>	<ul style="list-style-type: none"> <li>a) Turn sensitivity adjuster on timer unit</li> <li>b) Reposition Light</li> </ul>

## 6.1 Helpful Information

Heat from the transformer	The Silent Gliss 5090 transformer will feel slightly warm to touch. This is normal operating temperature and not a cause for concern.
Power consumption	Silent Gliss 5090 is designed for minimal power consumption and is, therefore, inexpensive to run.
Maintenance	In normal use, Silent Gliss 5090 will require no maintenance. There are no user-serviceable parts within the motor unit, timer unit or the transformer. If the supply cord becomes damaged it must only be replaced by the manufacturer, or its service agent, or a similarly qualified person in order to prevent a hazard.
Safety precautions	Do not exceed the maximum total curtain weight of 15 kg straight or 10 kg on a bent track.
Power cut	Timer settings will be retained for up to 48 hours in the event of a power cut.











[www.silentgliss.co.uk](http://www.silentgliss.co.uk)

Silent Gliss Ltd.  
Pyramid Business Park  
Poorhole Lane, Broadstairs  
Kent CT10 2PT

Tel: +44 (0) 1843 863571  
Fax: +44 (0) 1843 864503  
[sales@silentgliss.co.uk](mailto:sales@silentgliss.co.uk)